

If you need additional operating assistance after reading this owner's manual or to order replacement accessories, please call TOLL FREE : 1-800-287-4871.

VIDEO CASSETTE RECORDER C6240VD

 As an ENERGY STAR® Partner, our company has determined that this product meets the ENERGY STAR® guidelines for energy efficiency. ENERGY STAR® is a U.S. registered mark.



WARNING: TO REDUCE THE RISK OF FIRE OR ELECTRIC SHOCK, DO NOT EXPOSE THIS APPLIANCE TO RAIN OR MOISTURE.



CAUTION
RISK OF ELECTRIC SHOCK
DO NOT OPEN



CAUTION: TO REDUCE THE RISK OF ELECTRIC SHOCK, DO NOT REMOVE COVER (OR BACK). NO USER SERVICEABLE PARTS INSIDE. REFER SERVICING TO QUALIFIED SERVICE PERSONNEL.

The caution marking is located on the rear of the cabinet.



The lightning flash with arrowhead symbol, within an equilateral triangle, is intended to alert the user to the presence of uninsulated "dangerous voltage" within the product's enclosure that may be of sufficient magnitude to constitute a risk of electric shock to persons.



The exclamation point within an equilateral triangle is intended to alert the user to the presence of important operating and maintenance (servicing) instructions in the literature accompanying the product.

IMPORTANT SAFEGUARDS

- 1. Read Instructions-** All the safety and operating instructions should be read before the appliance is operated.
- 2. Retain Instructions-** The safety and operating instructions should be retained for future reference.
- 3. Heed Warnings-** All warnings on the appliance and in the operating instructions should be adhered to.
- 4. Follow Instructions-** All operating and use instructions should be followed.
- 5. Cleaning-** Unplug this video product from the wall outlet before cleaning. Do not use liquid cleaners or aerosol cleaners. Use a damp cloth for cleaning.

EXCEPTION: A product that is meant for uninterrupted service and, that for some specific reason, such as the possibility of the loss of an authorization code for a CATV converter, is not intended to be unplugged by the user for cleaning or any other purpose, may exclude the reference to unplugging the appliance in the cleaning description otherwise required in item 5.

- 6. Attachments-** Do not use attachments not recommended by the video product manufacturer as they may cause hazards.
- 7. Water and Moisture-** Do not use this video product near water, for example, near a bath tub, wash bowl, kitchen sink, or laundry tub, in a wet basement, or near a swimming pool, and the like.
- 8. Accessories-** Do not place this video product on an unstable cart, stand, tripod, bracket, or table. The video product may fall, causing serious injury to a child or adult, and serious damage to the appliance. Use only with a cart, stand, tripod, bracket, or table recommended by the manufacturer, or sold with the video product. Any mounting of the appliance should follow the manufacturer's instructions and should use a mounting accessory recommended by the manufacturer. An appliance and cart combination should be moved with care. Quick stops, excessive force, and uneven surfaces may cause the appliance and cart combination to overturn.



- 9. Ventilation-** Slots and openings in the cabinet are provided for ventilation and to ensure reliable operation of the video product and to protect it from overheating, and these openings must not be blocked or covered. The openings should never be blocked by placing the video product on a bed, sofa, rug, or other similar surface. This video product should not be placed in a built-in installation such as a bookcase or rack unless proper ventilation is provided or the manufacturer's instructions have been adhered to.
- 10. Power Sources-** This video product should be operated only from the type of power source indicated on the marking label. If you are not sure of the type of power supply to your home, consult your appliance dealer or local power company. For products intended to operate from battery power, or other sources, refer to the operating instructions.

- 11. Grounding or Polarization-** This video product is equipped with a polarized alternating-current line plug (a plug having one blade wider than the other). This plug will fit into the power outlet only one way. This is a safety feature. If you are unable to insert the plug fully into the outlet, try reversing the plug. If the plug should still fail to fit, contact your electrician to replace your obsolete outlet. Do not defeat the safety purpose of the polarized plug.
- 12. Power Cord Protection-** Power supply cords should be routed so that they are not likely to be walked on or pinched by items placed upon or against them, paying particular attention to cords at plugs, convenience receptacles, and the point where they exit from the appliance.
- 13. Outdoor Antenna Grounding-** If an outside antenna or cable system is connected to the video product, be sure the antenna or cable system is grounded so as to provide some protection against voltage surges and built-up static charges. Article 810 of the National Electrical Code, ANSI/NFPA No. 70, provides information with regard to proper grounding of the mast and supporting structure, grounding of the lead-in wire to an antenna discharge unit, size of grounding conductors, location of antenna discharge unit, connection to grounding electrodes, and requirements for the grounding electrode. (Fig. A)

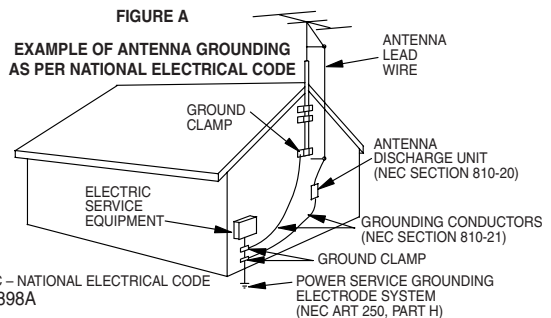

- 14. Lightning-** For added protection for this video product during a lightning storm, or when it is left unattended and unused for long periods of time, unplug it from the wall outlet and disconnect the antenna or cable system. This will prevent damage to the video product due to lightning and power-line surges.
- 15. Power Lines-** An outside antenna system should not be located in the vicinity of overhead power lines or other electric light or power circuits, or where it can fall into such power lines or circuits. When installing an outside antenna system, extreme care should be taken to keep from touching such power lines or circuits as contact with them might be fatal.
- 16. Overloading-** Do not overload wall outlets and extension cords as this can result in a risk of fire or electric shock.
- 17. Object and Liquid Entry-** Never push objects of any kind into this video product through any openings as they may touch dangerous voltage points or short-out parts that could result in a fire or electric shock. Never spill liquid of any kind on the video product.
- 18. Servicing-** Do not attempt to service this video product yourself as opening or removing covers may expose you to dangerous voltage or other hazards. Refer all servicing to qualified service personnel.
- 19. Damage Requiring Service-** Unplug this video product from the wall outlet and refer servicing to qualified service personnel under the following conditions:
 - When the power-supply cord or plug is damaged.
 - If liquid has been spilled, or objects have fallen into the video product.
 - If the video product has been exposed to rain or water.
 - If the video product does not operate normally by following the operating instructions. Adjust only those controls that are covered by the operating instructions as an improper adjustment of other controls may result in damage and will often require extensive work by a qualified technician to restore the video product to its normal operation.
 - If the video product has been dropped or damaged in any way.
 - If the video product exhibits a distinct change in performance-this indicates a need for service.
- 20. Replacement Parts-** When replacement parts are required, be sure the service technician has used replacement parts specified by the manufacturer or have the same characteristics as the original part. Unauthorized substitutions may result in fire, electric shock or other hazards.
- 21. Safety Check-** Upon completion of any service or repairs to this video product, ask the service technician to perform safety checks to determine that the video product is in proper operating condition.
- 22. Heat-** This video product should be situated away from heat sources such as radiators, heat registers, stoves, or other products (including amplifiers) that produce heat.

PRECAUTIONS

Install Location

For safety and optimum performance of your VCR:

- Install the VCR in a horizontal and stable position. Do not place anything directly on top of the VCR. Do not place the VCR directly on top of the TV.
- Shield it from direct sunlight and keep it away from sources of intense heat. Avoid dusty or humid places. Avoid places with insufficient ventilation for proper heat dissipation. Do not block the ventilation holes on the sides of the VCR. Avoid locations subject to strong vibration or strong magnetic fields.

Avoid the Hazards of Electrical Shock and Fire

- Do not handle the power cord with wet hands.
- Do not pull on the power cord when disconnecting it from AC wall outlet. Grasp it by the plug.

Moisture Condensation Warning

Moisture condensation may occur inside the unit when it is moved from a cold place to a warm place, or after heating a cold room or under conditions of high humidity. Do not use the VCR at least for 2 hours until its inside is dry.

FCC Warning

This equipment may generate or use radio frequency energy. Changes or modifications to this equipment may cause harmful interference unless the modifications are expressly approved in the instruction manual. The user could lose the authority to operate this equipment if an unauthorized change or modification is made.

Important Copyright Information

Unauthorized recording or use of broadcast television programming, video tape, film or other copyrighted material may violate applicable copyright laws. We assume no responsibility for the unauthorized duplication, use, or other acts which infringe upon the rights of copyright owners.

A Note about Recycling

This product's packaging materials are recyclable and can be reused. Please dispose of any materials in accordance with your local recycling regulations. Batteries should never be thrown away or incinerated but disposed of in accordance with your local regulations concerning chemical wastes.

Note to the Cable TV System Installer

This reminder is provided to call the Cable TV system installer's attention to Article 820-40 of the National Electrical Code, which provides guidelines for proper grounding – in particular, specifying that the cable ground shall be connected to the grounding system of the building, as close to the point of cable entry as possible.

CAUTION:
TO PREVENT ELECTRIC SHOCK, MATCH WIDE BLADE OF PLUG TO WIDE SLOT, FULLY INSERT.

DESCRIPTION OF CONTROLS

Front Panel

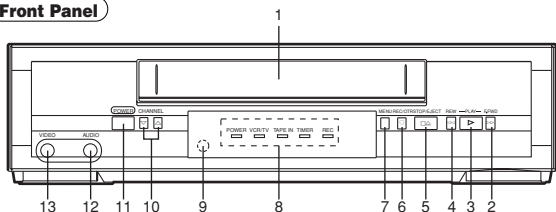

1. Cassette Compartment
2. F.FWD button
3. PLAY button
4. REW button
5. STOP/EJECT button
6. REC/OTR button
7. MENU button
8. Indicator
9. Remote Sensor
10. CHANNEL (▽/△) buttons
11. POWER button
12. AUDIO Input jack
13. VIDEO Input jack

Indicator



14. POWER indicator
15. VCR/TV indicator
16. TAPE IN indicator
17. TIMER indicator
18. REC indicator

Remote Control

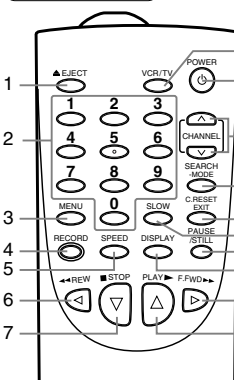

1. EJECT button
2. NUMBER buttons
3. MENU button
4. RECORD button
5. SPEED button
6. REW button
7. STOP button
8. PLAY button
9. F.FWD button
10. DISPLAY button
11. PAUSE/STILL button
12. SLOW button
13. C.RESET/EXIT button
14. SEARCH-MODE button
15. CHANNEL (▲/▼) buttons
16. POWER button
17. VCR/TV button

To insert the batteries

Install two AA batteries (supplied) matching the polarity indicated on the bottom of the remote control.

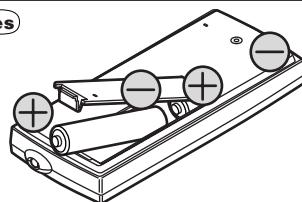

Rear Panel

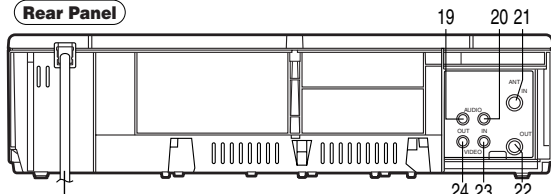

19. AUDIO OUT jack
20. AUDIO IN jack
21. ANT. IN jack
22. ANT. OUT jack
23. VIDEO IN jack
24. VIDEO OUT jack
25. AC Power Cord

VIDEO OUT Jack

Connect a video cable going to the video in jack of a camcorder, another VCR, a TV, or an audio-visual system (laser disc player, video disc player, etc.) here.

AUDIO OUT Jack

Connect the audio cable going to the audio in jack of a camcorder, another VCR, a stereo amplifier, or an audio system here.

VIDEO IN Jack

Connect a video cable coming from the video out jack of a camcorder, another VCR, or an audio-visual source (laser disc player, video disc player, etc.) here.

AUDIO IN Jack

Connect the audio cable coming from the audio out jack of a camcorder, another VCR, or an audio source here.

PREPARATION FOR USE

VCR to TV Connection

- 1 Disconnect the AC power cord of the TV from the AC outlet.
- 2 Disconnect the antenna or cable from the TV.
- 3 Connect the antenna or cable to the ANT. IN jack of the VCR.
- 4 Connect the VCR to the TV using the RF cable.
- 5 Plug the AC power cords of the VCR and TV into the AC outlets.

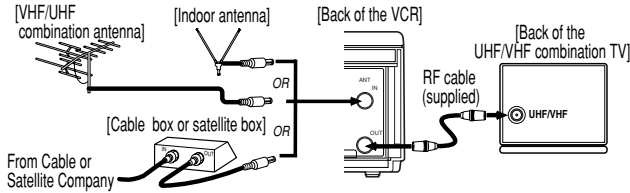

RF Output Channel

If your TV does not have A/V terminals:

Press [PLAY] on the VCR for 3 seconds during playback. The RF output channel will change to CH4 from CH3.

When you want to return to CH3 for RF output channel, press [PLAY] on the VCR for 3 seconds during playback again. (Default setting :CH3)

- There is case that the RF output channel does not change by situation (For example, when you adjust tracking using [CHANNEL (▽/△)]). In this case, stop the playback, and start the playback again. After that, press [PLAY] on the VCR for 3 seconds.
- If there is a power failure or the VCR is unplugged for more than 30 seconds, the RF output channel setting will return to CH3.

VCR to AV TV connection using AUDIO/VIDEO Cables

Using Optional AUDIO/VIDEO Output Jacks

With this connection, you can get better pictures and sounds when playing back a tape if your TV has A/V Input jacks. Please refer to your TV's owner's manual.

Using AUDIO/VIDEO Input Jacks

You can use the A/V input jacks on the front or the back of the VCR.

- To use the input jacks on the back of the VCR, select "L1" position by pressing [0], [0], [1] on the remote control or [CHANNEL (∧/∨)].
- To use the input jacks on the front of the VCR, select "L2" position by pressing [0], [0], [2] on the remote control or [CHANNEL (∧/∨)].
- "L1" or "L2" is found before the lowest memorized channel. (Example: CH2)

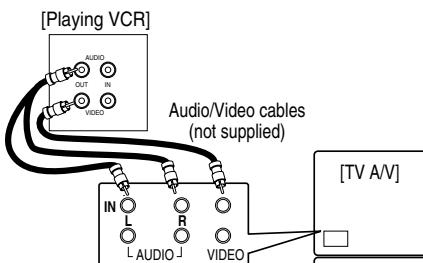

SETUP

Automatic Channel Set Up

You can automatically program the tuner to scan only the channels you receive in your area.

- Channel memory programming is NOT needed when you connect the VCR to a cable box or satellite box as in "Connect VCR to TV Connection". In this case, select the VCR and TV to channel 3 or 4 the same channel as the RF output channel of the VCR. Then, the channel you want to record or view may be selected at the cable box or satellite box.
- Follow the steps below once. Repeat it only if there is a power failure or if the VCR is unplugged for more than 30 seconds. (In these cases, the programmed channels are erased.)
- You must follow the steps below before attempting to play or record a video tape. If you want to play or record a video tape BEFORE programming the tuner, you can cancel it by pressing [C.RESET/EXIT].

- 1 You need to connect the antenna or cable to the VCR first. Then, connect the VCR power plug into a standard AC outlet.
- 2 Turn on the TV and set the TV to channel 3. If channel 3 is already occupied for broadcasting, change the RF output to CH 4, and change the TV channel to CH4. (See "RF Output Channel" on page 3 for the detail.)
- 3 Turn on the VCR by pressing [POWER]. When the POWER is on, both the POWER and VCR/TV indicator on the VCR will be on.
- 4 Select the On Screen Language ("ENGLISH", "FRANCAIS" or "ESPAÑOL") by pressing [PLAY] or [STOP]. Then, press [F.FWD].

LANGUAGE SELECT

▶ ENGLISH [ON]

FRANCAIS

ESPAÑOL
- 5 Begin channel preset by pressing [F.FWD] once. The tuner scans and memorizes all active channels in your area.

CH 01

AUTO SET UP

 - The VCR distinguishes between standard TV channels and cable channels.
- 6 After scanning, the tuner stops on the lowest memorized channel. The TV screen returns to TV mode.
 - If "AUTO SET UP" appears on the TV screen again, check the cable connections. Press [F.FWD] once again and the VCR will begin preset again.

To Select a Desired Channel

You can select the desired channel by using [CHANNEL (∧/∨)] or directly pressing [Number] on the remote control.

Note for using the Number buttons:

- When selecting cable channels which are higher than 99, enter channel numbers as a three-digit number. (For example: 117, press 1,1,7)
- You must precede single-digit channel numbers with a zero (For example: 02, 03, 04 and so on).

To Preset the Channel Again

- 1 Press [MENU] until the main menu appears.
- 2 Select "CHANNEL SET UP" by pressing [PLAY] or [STOP]. Then, press [F.FWD].
- 3 Select "AUTO SET UP" by pressing [PLAY] or [STOP]. Then, press [F.FWD]. After scanning, the tuner stops on the lowest memorized channel.

To Add/Delete Channels

When the VCR automatically program the tuner to scan only the channels you receive in your area, some channels may be skipped due to weak signal. You can manually add the channel in the VCR memory.

- 1 Press [MENU] until the main menu appears.
- 2 Select "CHANNEL SET UP" by pressing [PLAY] or [STOP]. Then, press [F.FWD].
- 3 Select "MANUAL SET UP" by pressing [PLAY] or [STOP]. Then, press [F.FWD].
- 4 Enter the desired channel number by pressing [PLAY] or [STOP].
- 5 Add or Delete it from memory by pressing [F.FWD] or [REW] so that "ADD" or "DELETE" flashes on the TV screen accordingly.
- 6 Exit the Preset mode by pressing [C.RESET/EXIT].

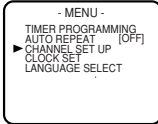

To Change the On-Screen Language

- 1 Press [MENU] until the main menu appears.
- 2 Select "LANGUAGE SELECT" by pressing [PLAY] or [STOP]. Then, press [F.FWD].
- 3 Select "ENGLISH", "FRANCAIS" or "ESPAÑOL" by pressing [PLAY] or [STOP]. Then, press [C.RESET/EXIT].
 - If you accidentally select Spanish or French and need English: Press [MENU] and choose SELEC. IDIOMA, or SELECTION LANGUE. Press [F.FWD], and select ENGLISH. Finally, press [C.RESET/EXIT].

Clock Set Up

- 1 Select main menu by pressing [MENU]. (If the clock is not set, the CLOCK SET menu appears first. In this case, follow step [3].)
- 2 Select "CLOCK SET" by pressing [PLAY] or [STOP]. Then, press [F.FWD].
- 3 Set the clock.

Set the month	Press [PLAY] or [STOP] repeatedly. Then, press [F.FWD].
Set the day	Press [PLAY] or [STOP] repeatedly. Then, press [F.FWD].
Set the year	Press [PLAY] or [STOP] repeatedly. Then, press [F.FWD]. The day of the week will appear automatically.
Set the hour	Press [PLAY] or [STOP] repeatedly. Then, press [F.FWD].
Set the minute	Press [PLAY] or [STOP] repeatedly. Then, press [F.FWD].
Set the AM or PM	Press [PLAY] or [STOP] repeatedly.

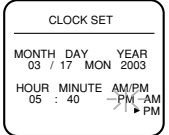

- To go back one step, press [REW].
- 4 Start the clock by pressing [C.RESET/EXIT] or [F.FWD].

PLAYBACK FUNCTION

Normal Playback

- 1 Insert the prerecorded tape. The VCR will turn on. If the safety tab has been removed, the VCR will start playback automatically. 
- 2 Turn on the TV and set the TV to channel 3. If channel 3 is already occupied for broadcasting, change the RF output to CH 4, and change the TV channel to CH4. (See "RF Output Channel" on page 3 for the detail.)
- 3 Begin playback by pressing [PLAY].
 - Tracking adjustment will be set automatically (Digital Tracking function) when you start playback. To adjust the tracking manually, press [CHANNEL (▽/△)] on the VCR.
 - You cannot manually adjust the tracking of a Still picture. However, you may press [CHANNEL (▽/△)] on the VCR to remove vertical jitter in a Still picture.
 - When a tape has reached the end, the VCR will rewind the tape to the beginning, eject the tape, and turn off the VCR automatically.
- 4 To stop playback, press [STOP].

Counter Reset

- You can reset the counter by pressing [C.RESET/EXIT] on the remote control

Still / Slow

You can freeze the picture on TV screen by pressing [PAUSE/STILL] during playback.

- You can advance the picture by one frame at a time by pressing [PAUSE/STILL] during the still mode.
- If the picture begins to vibrate vertically during the still mode, stabilize the picture by pressing [CHANNEL (▽/△)].
- If the picture is distorted or rolling vertically, adjust the vertical hold control on your TV, if equipped.

You can see the slow motion by pressing [SLOW] during playback or the still mode.

- If the noise bar appears on the TV screen, you can reduce it by pressing [CHANNEL (▽/△)].
- After the VCR has been in Still/Slow mode for 5 minutes, it will stop automatically to protect the tape and the video head from damage.
- To return playback, press [PLAY].

Auto Repeat Playback

This feature allows you to play a tape over and over.

- 1 Select main menu by pressing [MENU].
- 2 Select "AUTO REPEAT" by pressing [PLAY] or [STOP].
- 3 Begin auto repeat playback by pressing [F.FWD] so that [ON] appears next to "AUTO REPEAT".
 - If the on-screen menu still remains, press [C.RESET/EXIT] to exit the menu.
 - To cancel the Auto repeat mode, press [F.FWD] at step [3] so that [OFF] appears next to "AUTO REPEAT".

Search Functions

Picture Search

If you want to skip or repeat a scene during playback, press [F.FWD] or [REW].

- Press it again and the VCR will now search in super high speed. (in the LP/SLP modes only)

Index Search

An index mark will be assigned at the beginning of each recording you make. You may skip to a specific marked point by following the steps below.

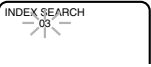
- 1 Press **[SEARCH-MODE]** so that the Index Search menu appears.
- 2 Enter the number of recordings you wish to skip by pressing **[PLAY]** or **[STOP]** within 30 seconds. 
- 3 Press **[F.FWD]** or **[REW]** to start index search. If you want to go in the forward direction, press **[F.FWD]**. If you want to go in the reverse direction, press **[REW]**.
 - After index search, the VCR will play the tape automatically.

Time Search

This feature allows you to go to a specific point on a tape by entering the exact amount of time you wish to skip in order to reach the point.

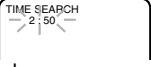
- 1 Press **[SEARCH-MODE]** so that the Time Search menu appears. 
- 2 Enter your desired time to skip by pressing **[PLAY]** or **[STOP]** within 30 seconds.
- 3 Press **[F.FWD]** or **[REW]** to start time search. If you want to go in the forward direction, press **[F.FWD]**. If you want to go in the reverse direction, press **[REW]**.
 - After time search, the VCR will play the tape automatically.

RECORDING FUNCTION

It may be unlawful to record play back copyrighted material without the consent of the copyright owner.

Accidental erasure prevention

To prevent accidental recording on a recorded cassette, remove its record safety tab. To record on it later, cover the hole with cellophane tape.

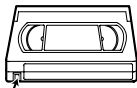

Record safety tab

Before recording, make sure:

- The desired channel is selected by pressing **[Number]** on the remote control or the **[CHANNEL (^/v)]**. (If you connected the VCR to a cable box or satellite box as in "VCR to TV Connection" on page 3, select the VCR to channel 3 or 4 the same channel as the RF output channel of the VCR. Then, select the channel you want to record at the cable box or satellite box. In this case, you can ONLY record and view the SAME channel.)
- There is a tape with its safety tab into the VCR.
- The desired recording speed is selected in **SP**(standard play) or **SLP**(super long play) mode by pressing **[SPEED]** on the remote control.

Tape Speed	Recording/Playback Time		
	Type of tape	T60	T120
SP mode	1hour	2hours	2-2/3hours
SLP mode	3hour	6hour	8hour

Viewing and Recording the Same Program

- 1 Begin the recording by pressing **[RECORD]**.
 - To temporarily stop recording or resume it, press **[PAUSE/STILL]**. After the VCR has been in Pause mode for 5 minutes, it will stop automatically to protect the tape and the video head from damage.

- 2 Press **[STOP]** when recording is completed.

OTR (One Touch Recording)

This feature allows you to set the recording length simply by pressing **[REC/OTR]** on the VCR.

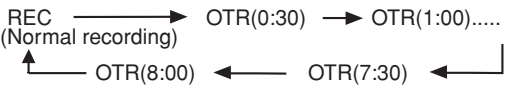
- 1 Begin OTR by pressing **[REC/OTR]** on the VCR repeatedly until the desired recording length appears.
 

TIMER RECORDING

You may set the VCR to start recording while you are away. You can set eight programs to record on specific days, daily or weekly within a 1 year period.

- 1 Insert a tape with its safety tab into the VCR.
- 2 Select main menu by pressing **[MENU]**.
- 3 Select **"TIMER PROGRAMMING"** by pressing **[PLAY]** or **[STOP]**. Then, press **[F.FWD]**.
 - If you have not yet set the clock, "CLOCK SET" appears. If so, continue with the step [3] in "CLOCK SET UP" section. Then, set the timer recording.
- 4 Set the timer.

Set the program number (1-8)

Program number which is not set up flashes. Press **[PLAY]** or **[STOP]** repeatedly for the desired program number. Then, press **[F.FWD]**.

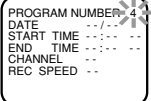

Select once, daily or weekly recording

- **For once:** Press **[PLAY]** or **[STOP]** to point to "ONCE".
- **For daily (Monday~Friday):** Press **[PLAY]** or **[STOP]** to point to "DAILY".
- **For weekly:** Press **[PLAY]** or **[STOP]** to point to "WEEKLY". Then, press **[F.FWD]**.

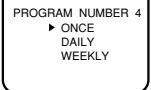

Set the date

First, press **[PLAY]** or **[STOP]** for the month. Then, press **[F.FWD]**. Next, press **[PLAY]** or **[STOP]** for the day. Then, press **[F.FWD]**.

Set the start time

First, press **[PLAY]** or **[STOP]** for the hour. Then, press **[F.FWD]**. Next, press **[PLAY]** or **[STOP]** for the minute. Then, press **[F.FWD]**. And then, press **[PLAY]** or **[STOP]** for AM or PM. Then, press **[F.FWD]**.

Set the end time

Follow the instructions of "Set the start time" to set the end time.

Set the channel number

Press **[PLAY]** or **[STOP]** repeatedly for the desired channel number. Then, press **[F.FWD]**.
 • If you connected the VCR to a cable box or satellite box as in "Connect VCR to TV" on page 3, select the VCR to channel 3 or 4 the same channel as RF output channel of the VCR.
 Then, select the channel you want to record at the cable box or satellite box. Leave the cable box or satellite box on for timer recording.

Set the tape speed

Press **[PLAY]** or **[STOP]** repeatedly for the desired tape speed. Then, press **[F.FWD]**.

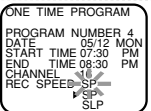

- To go back one step, press **[REW]**.
- 5 To set another program, repeat step [4]. To exit, press **[C.RESET/EXIT]**.
 - 6 Press **[POWER]** to set the timer. The **TIMER** indicator on the VCR comes on. **TIMER RECORDING WILL NOT BE ACTIVATED UNLESS YOU TURN THE VCR OFF.**

Hints for Timer Recording

- If there is a power failure or the VCR is unplugged for more than 30 seconds, the clock setting and all timer settings will be lost.
- If the tape runs out before the end time, the VCR will switch to the Stop mode immediately, eject the tape and the VCR power will be turned off. The TIMER indicator will flash.
- If a tape is not in the VCR or does not have the safety tab, the TIMER indicator flashes and timer recording cannot be performed. Please insert a recordable tape.

To Stop an Automatic Timer Program already started

Press [STOP/EJECT] on the VCR.

To Check, Correct, or Cancel an Automatic Timer Program

- 1 Turn the power on by pressing [POWER].
- 2 Select main menu by pressing [MENU].
- 3 Select "TIMER PROGRAMMING" by pressing [PLAY] or [STOP]. Then, press [F.FWD].
- 4 Select the program number which you want to check by pressing [PLAY] or [STOP]. The details of the selected program appears on the TV screen.
 - Go to the digit you want to change by pressing [F.FWD] or [REW]. Then, enter correct numbers by pressing [PLAY] or [STOP].
 - You may cancel the entire program by pressing [REW] during the program number flashes.
- 5 Press [C.RESET/EXIT] to exit.
- 6 Press [POWER] to return to timer stand-by mode.

SPECIAL FEATURES

Copying a Video Tape

You can make copies of video tapes made by friends or relatives for your enjoyment.

Warning: Unauthorized recordings of copyrighted video tapes may be an infringement of copyright laws.

Connect the recording VCR (this unit), the playing VCR (another source) and your TV using the following diagram.

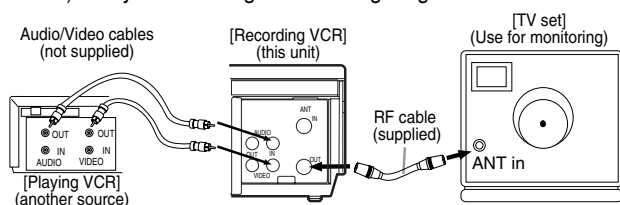

- 1 Insert a pre-recorded tape into the playing VCR.
- 2 Insert a tape with its safety tab into the recording VCR.
- 3 Press [SPEED] on the remote control of the recording VCR to select the desired recording speed (SP/SLP).
- 4 Select the "L1" or "L2" position on the recording VCR. See page 3, under "Using AUDIO/VIDEO Input Jacks".
- 5 Press [REC/OTR] on the recording VCR.
- 6 Begin playback of the tape in the playing VCR.

- For best results during dubbing, use the VCR's front panel controls whenever possible. The remote control might affect the playing VCR's operation.
- Always use video-quality shielded cables with RCA-type connectors. Standard audio cables are not recommended.
- You can use a video disc player, satellite receiver, or other audio/video component with A/V outputs in place of the playing VCR.

To Monitor the Recording

- 1 Turn on the TV and set the TV to channel 3. If channel 3 is already occupied for broadcasting, change the RF output to CH 4, and change the TV channel to CH4. (See "RF Output Channel" on page 3 for the detail.)
- 2 Press [VCR/TV] on the remote control of the recording VCR so that the VCR/TV indicator comes on.

Auto Rewind

When a tape has reached the end during recording, playback, or fast-forward, the tape will automatically rewind to the beginning. After rewinding finishes, the VCR will eject the tape and turn itself off.

- The VCR will not rewind the tape automatically during timer recording or One Touch Recording.

Real Time Tape Counter

- This shows the elapsed recording or playback time in hours, minutes, and seconds. (The displayed time will not change during blank portions on the tape.)
- The indication will appear when the tape is rewound further than "0:00:00" on the tape counter.

TROUBLESHOOTING GUIDE

If you have followed the instructions contained in this manual and have difficulty in operating your VCR, locate the PROBLEM in the left column below. Check the corresponding CORRECTIVE ACTION column to remedy the problem.

PROBLEM	CORRECTIVE ACTION
No power.	<ul style="list-style-type: none"> • Make sure the power plug is connected to an AC outlet. • Make sure the power is turned on.
Timer recording is impossible.	<ul style="list-style-type: none"> • Make sure the timer recording is set correctly. • Make sure the power is off. • Make sure the VCR clock is set correctly.
Cannot go into Record mode.	<ul style="list-style-type: none"> • Make sure the tape has a safety tab. If needed, cover the hole with cellophane tape.
Playback picture is partially noisy.	<ul style="list-style-type: none"> • Adjust tracking control for a better picture by pressing [CHANNEL (▽/△)] on the VCR.
Cannot view a tape but the audio is OK.	<ul style="list-style-type: none"> • Head cleaning may be necessary. Refer to "AUTO HEAD CLEANING". • Make sure the VCR is not in the Menu mode.
No or poor playback picture.	<ul style="list-style-type: none"> • Turn on the TV and set the TV to channel 3. If channel 3 is already occupied for broadcasting, change the RF output to CH 4, and change the TV channel to CH4. (See "RF Output Channel" on page 3 for the detail.) • Fine tune your TV.
TV programs cannot be seen normally.	<ul style="list-style-type: none"> • Re-check the ANT. IN and ANT. OUT connections. See page 3. • Press [VCR/TV] on the remote control so that the VCR/TV indicator on the VCR disappears.
No VCR operation from the infrared Remote Control.	<ul style="list-style-type: none"> • Make sure the power plug is connected to an AC outlet. • Check batteries in remote control.
Video or color fades in and out when making a copy of a video tape.	<ul style="list-style-type: none"> • You cannot copy a copyrighted video tape. You are experiencing copy guard protection.

SPECIFICATIONS

Operating temperature : 41°F~104°F (5°C~40°C)
 Converter output : VHF Channel 3 or 4.
 Power requirement : 120V, 60Hz
 Power consumption : 14 Watts

Dimensions : W 14-1/4" (360mm)
 H 3-5/8" (92mm)
 D 8-1/2" (216mm)
 Weight : 4.0 lbs. (1.8 Kg.) (approx.)

Supplied Accessories

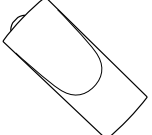
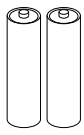
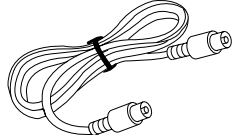
Remote control  (NA311UD/NA361UD)	Two AA batteries 	RF Cable 
--	---	--

- Designs and specifications are subject to change without notice and legal obligation.
- If there is a discrepancy between languages, the default language will be English.

MAINTENANCE

Servicing

Should your VCR become inoperative, do not try to correct the problem by yourself. There are no user-serviceable parts inside. Turn off, unplug the power plug, and please call our help line at

1-800-287-4871,

to locate an Authorized Service Center.

Cabinet Cleaning

- Wipe the front panel and other exterior surfaces of the VCR with a soft cloth immersed in lukewarm water and wrung dry.
- Never use a solvent or alcohol. Do not spray insecticide liquid near the VCR. Such chemicals may cause damage and discoloration to the exposed surfaces.

Auto Head Cleaning

- Automatically cleans video heads as you insert or remove a cassette, so you can see a clear picture.
- Playback picture may become blurred or interrupted while the TV program reception is clear. Dirt accumulated on the video heads after long periods of use, or the usage of rental or worn tapes can cause this problem. If a streaky or snowy picture appears during playback, the video heads in your VCR may need to be cleaned.

1. Please visit your local Audio/Video store and purchase a good quality VHS Video Head Cleaner.
2. If a Video Head Cleaner does not solve the problem, please call our help line at 1-800-287-4871, to locate an Authorized Service Center.

NOTES:

- Remember to read the instructions included with the video head cleaner before use.
- Clean video heads only when problems occur.

SYLVANIA HOME ENTERTAINMENT WARRANTY

We appreciate your purchase of a SYLVANIA Home Entertainment product. We take pride in the quality of our products and have manufactured your new Home Entertainment unit to exacting quality standards. We feel confident that in normal use, it will provide you with satisfactory performance. However, should you experience difficulty, you are protected under the provisions of this warranty.

SYLVANIA Home Entertainment products are warranted against manufacturing defects in materials and workmanship in normal use for the following periods from the date of purchase by the original user, and is conditional upon the unit being installed and used as directed in the instruction manual.

Product	Parts and Labour
V.C.R.	1 Year
Video Head	6 Months
Remote Control	90 Days

SYLVANIA's obligation under this warranty shall be limited to the repair, including all necessary parts and the cost of the labour connected therewith, or at our option the exchange of any Home Entertainment product which shows evidence of a manufacturing defect within the warranty period.

Replacement parts, furnished in connection with this warranty shall be warranted for a period equal to the unexpired portion of the original equipment warranty.

CUSTOMER OBLIGATIONS

This warranty applies to the product from the original date of purchase at retail. Therefore, the owner must provide a copy of the original, dated bill of sale. No warranty service will be performed without a bill of sale. Transportation to and from the service depot is the responsibility of the owner.

WARRANTY EXCLUSIONS

This warranty is extended to SYLVANIA Home Entertainment products purchased and used in Canada. This warranty shall not apply to appearance or accessory items including but not limited to: cabinet, cabinet parts, batteries, connecting cables, tapes. This warranty shall, in addition, not apply to cleaning video/audio heads, pinch rollers, tape transport system damages due to handling, transportation, unpacking, set-up, installation, customer adjustments that are covered in the instruction book, repair or replacement of parts supplied by other than the SYLVANIA authorized service depot, any malfunction or failure caused by or resulting from abnormal environmental conditions, improper unauthorized service, improper maintenance, modifications or repair by the consumer, abuse, misuse, neglect, accident, fire, flood, or other Acts of God, and incorrect line voltage.

This Home Entertainment product is only warranted to the original retail purchaser. This warranty becomes void in the event of commercial or rental use. This warranty becomes void in the event serial numbers are altered, defaced or removed.

SYLVANIA reserves the right to make changes in design or to make additions to or improvements upon this product without incurring any obligation to install the same on products previously manufactured. The foregoing is in lieu of all other warranties expressed or implied and SYLVANIA neither assumes nor authorizes any person to assume for it any other obligation or liability in connection with the sale or service of this product. In no event shall SYLVANIA or its SYLVANIA dealers be liable for special or consequential damage arising from the use of this product, or for any delay in the performance of this warranty due to cause beyond our control. The purchaser may have other rights under existing provincial or federal laws, and where any terms of this warranty are prohibited by such laws, they are deemed null and void, but the remainder of the warranty shall remain in effect.

HOW TO OBTAIN SERVICE

Should this product require service, you may obtain specific information on how to obtain service by contacting the SYLVANIA Dealer from whom this product was purchased, or by contacting us directly:

SONIGEM SERVICE

300 Alden Road
Markham, Ontario
L3R 4C1

PHONE: (905) 940-5089 FAX: (905) 940-2303
1-800-287-4871